

# KEYLESS360

THE PERFECT RETROFIT LOCK

EXPERIENCE THE PERFECT LOCKS

## SIMPLY PERFECT. PERFECTLY SIMPLE.

Sleek and modern alphanumeric combination locks for shared or assigned use in any wet or dry environment. With a standard vertical 3-hole routing, the Keyless360 is the Perfect Retrofit Lock.

With no batteries to change, no plastic parts and no wires, our locks are maintenance free resulting in zero operating expenses and two LEED V4 credits.

Standard, premium and custom finishes as well as ADA versions all backed by personal service and the best 5-year comprehensive warranty.



## OUR CLIENTS



amazon

BOEING

Capital One



Coca-Cola



EQUINOX

facebook



Google

HYATT



LIFETIME  
FITNESS



Mercedes-Benz



PEPSICO



REBEL



VISA

# KEYLESS360

## ARCHITECTURAL SPECIFICATIONS



PART NUMBER:  
**KEYLESS360-SN**  
**KEYLESS360-SN-ADA**

STANDARD FINISH:  
SATIN NICKEL



PART NUMBER:  
**KEYLESS360-MB**  
**KEYLESS360-MB-ADA**

PREMIUM FINISH:  
MATTE BLACK  
MUNSELL N2/



PART NUMBER:  
**KEYLESS360-MW**  
**KEYLESS360-MW-ADA**

PREMIUM FINISH:  
MATTE WHITE  
MUNSELL N9/

10% color discrepancy and custom pricing options apply.

- 2-digit alphanumeric combination
- Compatible with wood, glass, plastic, phenolic and metal locker doors
- One Master Key has 3 functions: bypasses the code, resets the lock, and retrieves the code - all conveniently from the front
- Lock features reprogrammable-cylinder: When Master Key is lost or stolen, new Master Key is issued. Simply insert new Master Key and cylinder is reprogrammed - patented solution
- Anti-pick and tamper resistant
- Self-correcting, Breakaway Knob protects against forced entry - patented solution
- IP69K - Complete dust and water resistance
- Strong 100% metal for long-term and heavy-use - no plastic components.
- Large, clear combination digits, double the size of any competitors (5mm tall), that don't fade
- Sufficient digit and dial spacing that prevents accidental lockouts
- Strongest latch (bolt) in the industry and cannot be forced unlocked
- Dead bolt or spring bolt latch type (standard offset: 31mm - additional available)
- Simple 2 screw installation
- Surface mounted
- Accommodates doors 1-21mm thickness
- Easily retrofits from most locks on most locker doors. "The Ultimate Retrofit Lock"
- Ergonomic non-slip grip
- One step twist-&-pull operation
- Knob rotates 90 degrees (from 12 o'clock to 3 o'clock) on left and right hand locks
- Latch is simply interchangeable to left or right
- Clear locked and unlocked status indicator is visible from a distance
- Disinfected by misting with a liquid that is 70%-80% alcohol without damaging the surface of the lock
- **Immediate live response during business hours**  
- no run around. (sos@keyless.co or 972.331.2770)

### TOP VIEW 1-6MM DOOR THICKNESS

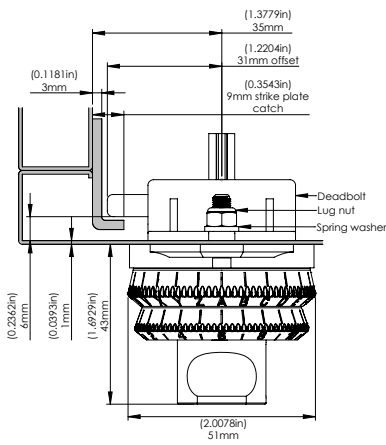

### TOP VIEW 6-21MM DOOR THICKNESS

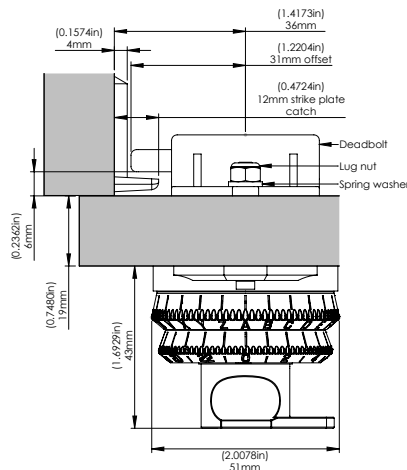

### FRONT VIEW

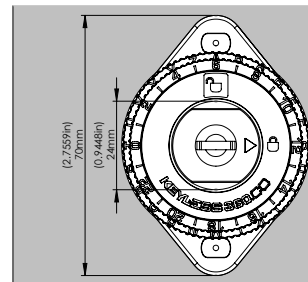

### DOOR ROUTING

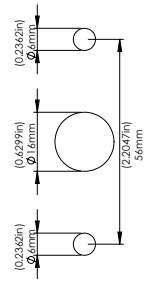

### 2010 & 2012 ADA STANDARDS FOR ACCESSIBLE DESIGN REQUIREMENTS



- 5% of lockers and their operable parts, the locks, must meet ADA specifications.
- Locks shall be operable with one hand.
- Shall not require tight grasping, pinching, or twisting of the wrist to operate.
- Shall have a force required to activate of 5lbs (22.2N) maximum.
- Locks shall be installed maximum 48.00"/1220mm from the floor surface.

### ADA MODEL WITH INTEGRATED LEVER SERVING AS A PULL

Meets the 2010 and 2012 Standards for Accessible Design

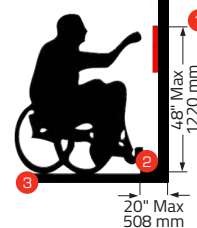

- 1 Highest touch point
- 2 Front edge of block
- 3 Top of finished floor

Manufactured By:

**KEYLESS.CO**



1825 W. Walnut Hill Ln., Suite 102, Irving, TX 75038, USA | +1 972-331-2770 | info@keyless.co | www.keyless.co | V: 6/17/2020

# KEYLESS360

## INSTRUCTIONS

## USER INSTRUCTIONS



### TO LOCK

1. Close the door.
2. Make sure knob is pointing up to , then set any 2 – digit code.
3. Turn knob to .
4. Scramble the dials.

#### CLICK LINK:

<https://www.keyless.co/keyless360/instructions/user/>

### TO UNLOCK

1. Re-enter your code.
2. Turn the knob up to .
3. Open the door.
4. Keeping the knob facing , scramble the dials for the next user.





**SCAN QR CODE  
TO VIEW USER  
INSTRUCTION VIDEO:**



## MANAGER INSTRUCTIONS

### MASTER KEY CODE BYPASS





(immediate manager access without code obstruction)

1. Insert the Master Key pointing towards the .
2. Turn the knob to  and access the locker, then close the door while keeping the knob facing .
3. Return the knob to the  position, and remove the key.

*\*Locker will remain locked and code will remain the same.*

### USER CODE RETRIEVAL & RESET

(retrieve forgotten user code and reset code for new user)

1. Insert the Master Key pointing towards the  and turn the knob to .
2. With each dial: spin until it stops.
  - After setting each dial, the last used code will display.
3. Turn the knob back to  and remove the key.
  - Then, return the knob to  and scramble the dials for the next user.

#### CLICK LINK:

<https://www.keyless.co/keyless360/instructions/reset/>

**SCAN QR CODE TO VIEW  
CODE RETRIEVAL & RESET  
INSTRUCTION VIDEO:**

